



Photovoltaic fuses

gPV curve

from 1 to 600 A, up to 1500 VDC

Fuse protection

new



Function

SOCOME **gPV fuses** protect the installation against the inverse over-currents which could occur in photovoltaic installations.

Advantages

Breaking capacity up to 1500 VDC

High breaking capacity at 1500 VDC.

Product dedicated to PV installations

Operating ranges adjusted for small over-currents specific to PV installations.

High reliability

- Absolute protection over time guaranteed by the simplicity of manufacture and function (Joule effect).
- No downgrading of fuse characteristics over time.

Improved safety

The energy released whilst eliminating the fault (fuse blowing) is contained within the cartridge (no degassing).

What you need to know

Used characteristics

- I_{SC} : short circuit current of the string
- $I_{SC\ MAX}$: short circuit current of the string related to maximum sunlight density
- I_{RM} : maximum admitted reverse current
- I_n : fuse rating or fuse rated current (at 25°C in a RM disconnect switch)
- N_c : number of strings connected in parallel
- U_e : maximum fuse rated voltage
- $U_{OC\ MAX}$: maximum open circuit voltage in the lowest temperature conditions.

When to protect

A PV string requires an over-current protection when its own maximum admissible reverse current characteristic (I_{RM}) is less than the current generated by the rest of the installation (current generated by the "Nc-1" other strings).

How to protect

The overload protection is to be applied at each of the two polarities, regardless of whether the DC installation is earthed or not.

The solution for

- Photovoltaic protection



Strong points

- Breaking capacity up to 1500 VDC
- Product dedicated to PV installations
- High reliability
- Improved safety

Large range

- Additional range of disconnect switches and fuse bases - dedicated connection accessories.

Conformity to standards

- IEC 60269-6
- IEC 60269-1
- IEC 60269-2



How to choose the fuse protection

Voltage

$$U_o > U_{OC\ MAX}$$

In the absence of complementary information use $U_{OC\ MAX} = 1,2 U_{OC}$.

Fuse rating determination

Determination of the fuse rated current consists of choosing a protection capable of:

- Supporting without fusing the normal overload current during the periods of maximum sunlight density at the ambient temperature of the enclosure in which the fuse is installed, $I_n > I_{SC\ MAX}$
In the absence of complementary information, use $I_{SC\ MAX} = 1,4 I_{SC}$
- Melting and reliably clearing the fault before the PV modules are damaged by the reverse current. $I_n < I_{RM}$

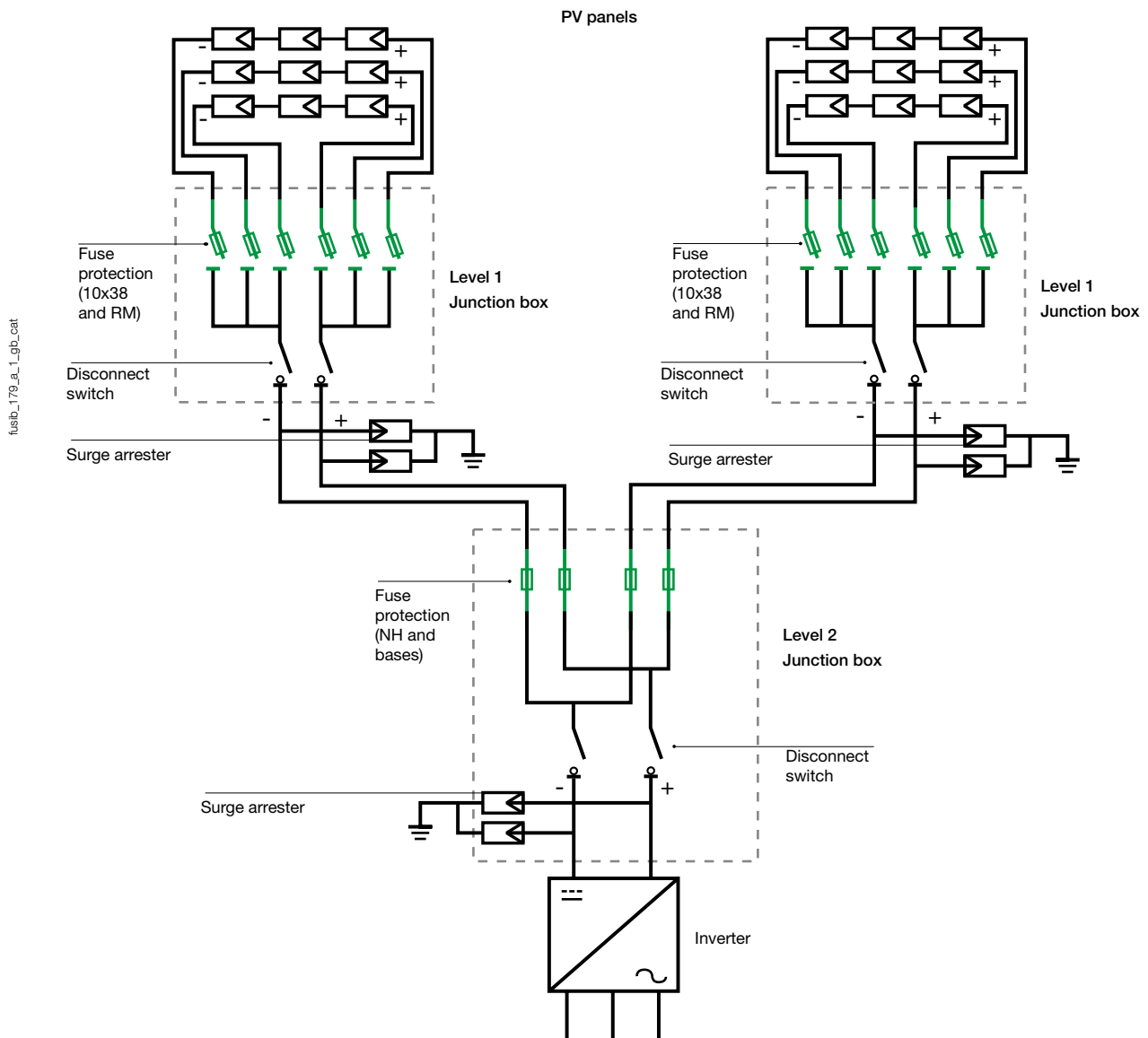

Photovoltaic fuses

gPV curve

from 1 to 600 A

References

Rated voltage 1000 VDC

Rating (A)	Fuse size	Dissipated power		Breaking capacity	Reference
		W@ In	W @ 0.8 In		
1	10 x 38	0,76	0,43	30 kA	60PV 0001
2	10 x 38	1,54	0,84	30 kA	60PV 0002
3	10 x 38	1,35	0,74	30 kA	60PV 0003
4	10 x 38	1,84	1,08	30 kA	60PV 0004
6	10 x 38	2,50	1,40	30 kA	60PV 0006
8	10 x 38	2,57	1,47	30 kA	60PV 0008
10	10 x 38	2,58	1,51	30 kA	60PV 0010
12	10 x 38	2,61	1,42	30 kA	60PV 0012
15	10 x 38	2,44	1,08	30 kA	60PV 0015
16	10 x 38	2,70	1,56	30 kA	60PV 0016
20	10 x 38	2,99	1,75	30 kA	60PV 0020
25	14 x 51	5,1	2,7	10 kA	60PV 0C25
32	14 x 51	6,2	3,3	10 kA	60PV 0C25
32	NH1	8,5	4,3	50 kA	60PV 0032
40	NH1	9	4,6	50 kA	60PV 0040
50	NH1	10,5	5,4	50 kA	60PV 0050
63	NH1	12	6,1	50 kA	60PV 0063
80	NH1	15,5	7,9	50 kA	60PV 0080
100	NH1	16,5	8,4	50 kA	60PV 0100
125	NH1	17,5	8,9	50 kA	60PV 0125
160	NH1	24	12,2	50 kA	60PV 0160
200	2XL	50	28	33 kA	60PV 0200
250	2XL	60	34	33 kA	60PV 0250
315	2XL	66	40	33 kA	60PV 0315
355	2XL	68	42	50 kA	60PV 0355
400	3L	82	48	50 kA	60PV 0400
500	3L	85	50	50 kA	60PV 0500
600	3L	118	92	50 kA	60PV 0600

Rated voltage 1500 VDC

Rating (A)	Fuse size	Dissipated power			Breaking capacity	Reference
		W@ In	W @ 0,7 In	W @ 0.8 In		
2	10x85	3,42	1,28		10	61PV 0002
4	10x85	2,91	1,16		10	61PV 0004
6	10x85	2,65	1,1		10	61PV 0006
8	10x85	2,79	1,16		10	61PV 0008
10	10x85	4,38	1,81		10	61PV 0010
12	10x85	4,43	1,83		10	61PV 0012
16 ⁽¹⁾	10x85	4,13	1,75		10	61PV 0016
20 ⁽¹⁾	10x85	5,14	2,13		10	61PV 0020
25 ⁽¹⁾	10x85	5,48	2,28		10	61PV 0025
200	1XL	61		31	30	61PV 0200
400	3L	91		49	30	61PV 0400

(1) Rated voltage 1200 VDC.

gPV knife edge fuse

Description of accessories	Size NH1 Reference	Size 1XL Reference	Size 2XL Reference	Size 3L Reference
Fuse blown auxiliary contact	56PV 9901	56PV 9901	56PV 9901	56PV 9901
Fuse base recommended	65PV 1011	-	65PV 1112	65PV 1113

Ambient temperature derating factor

$$I_{nf} = I_{cgens} / K_t$$

I_{nf} - gPV fuse rated current.

I_{cgens} - PV generator short circuit current under STC.

K_t - derating factor.

Max. ambient temperature (C)	Kt: Derating factor
20	1
40	0,92
45	0,90
50	0,87
55	0,85
60	0,82
65	0,79
70	0,76

Standard dimensions (mm) as per IEC 60269-2

gPV cylindrical Fuses

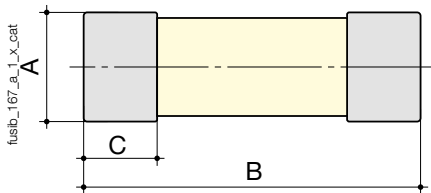

Size	Striker	A	B	C
10 x 38	without	10,3	38	10,5
14 x 51	without	14,3	51,5	10,10
10 X 85	without	10,3	85	10,5

gPV knife edge fuse

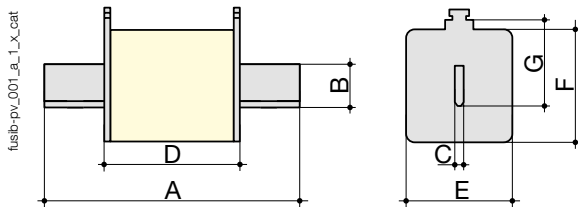

Size	Striker	A maxi	B	C	D maxi	E maxi	F maxi	G
NH1	without	137	20	6	67,7	39,65	52,9	40
1XL	without	189,8	20	5,8	127,8	51	51	39,8
2XL	without	204,5	26	5,8	123,3	59,2	59,2	47,9
3L	without	204,9	32,3	6	122,3	73,5	73,5	60

Photovoltaic fuses

gPV curve

from 1 to 600 A

Time/current operation characteristics

gPV cylindrical fuses 10x38

fusib-pv_002_a_1_gb_cat

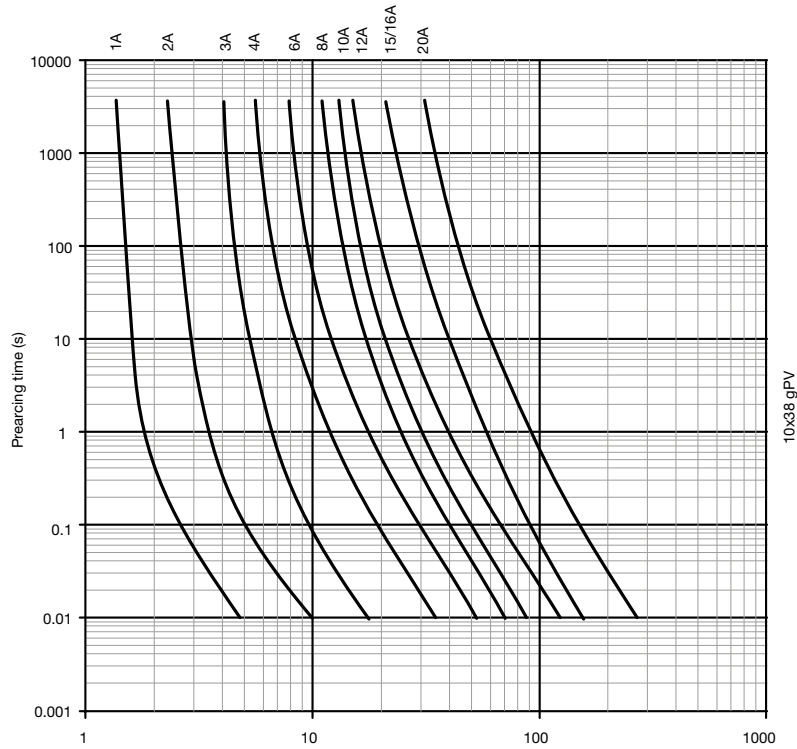

gPV cylindrical fuses 14x51

fusib-pv_003_b_1_gb_cat

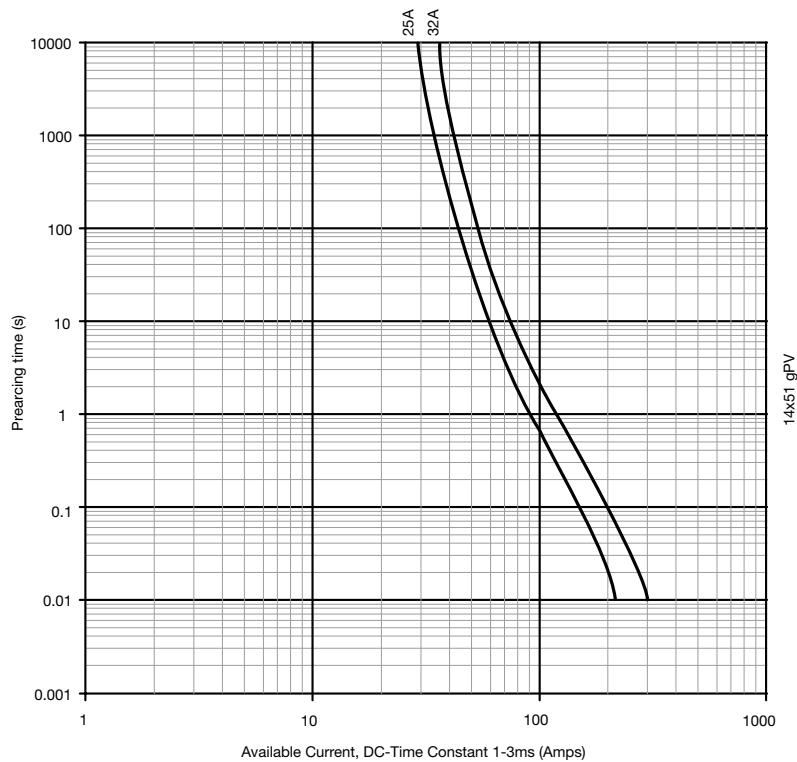

gPV cylindrical fuses 10x85 gPV

fusib-pv_027_a_1_gb_cat

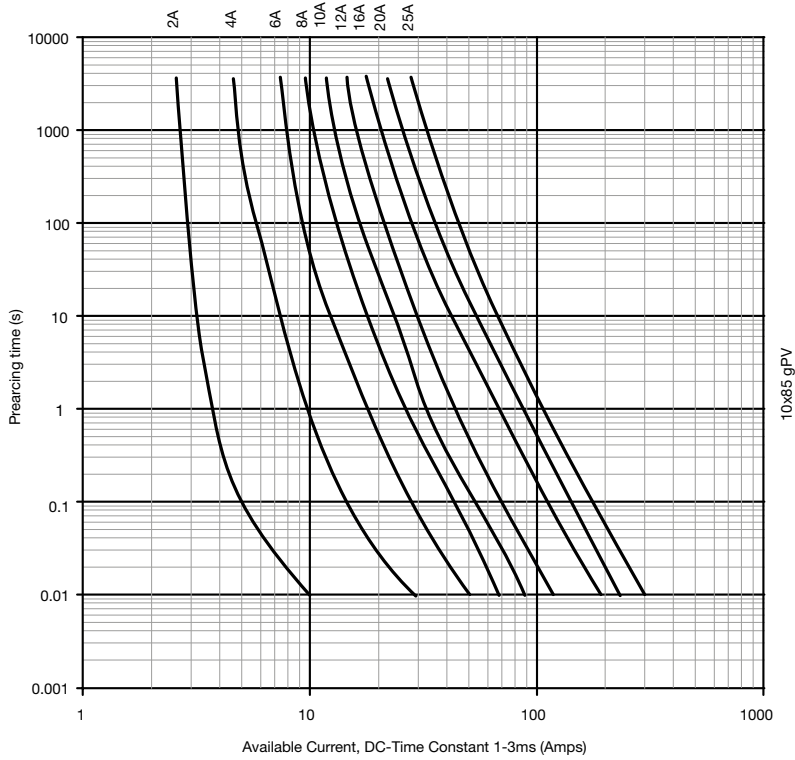

gPV knife edge fuse (NH1)

fusib-pv_004_b_1_gb_cat

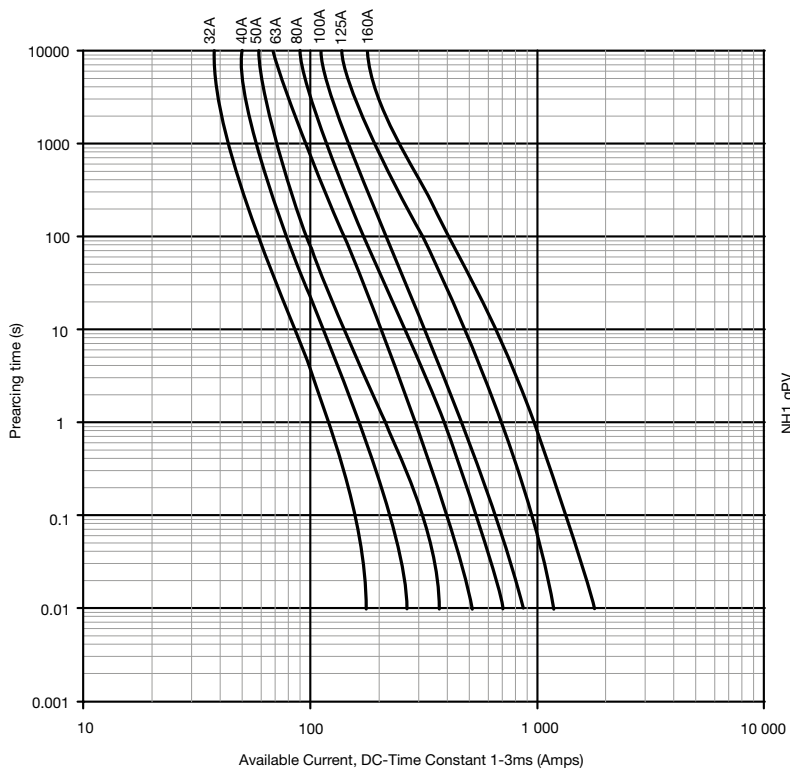

Photovoltaic fuses

gPV curve

from 1 to 600 A

Time/current operation characteristics (continued)

gPV knife edge fuse (1XL)

fusib-pv_028_a_1_gb_cat

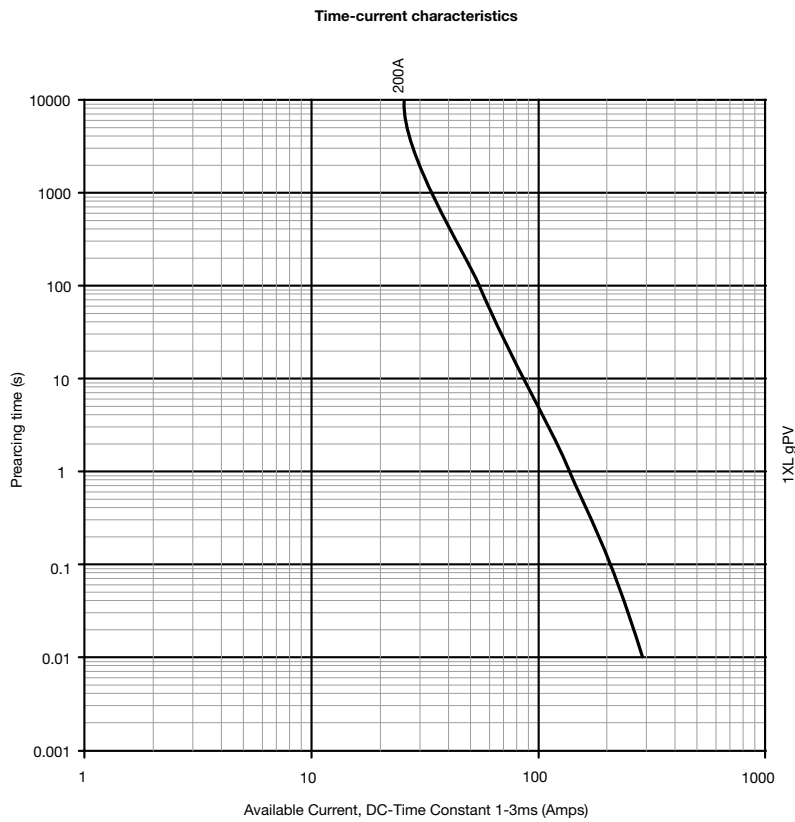

gPV knife edge fuse (2XL)

fusib-pv_005_b_1_gb_cat

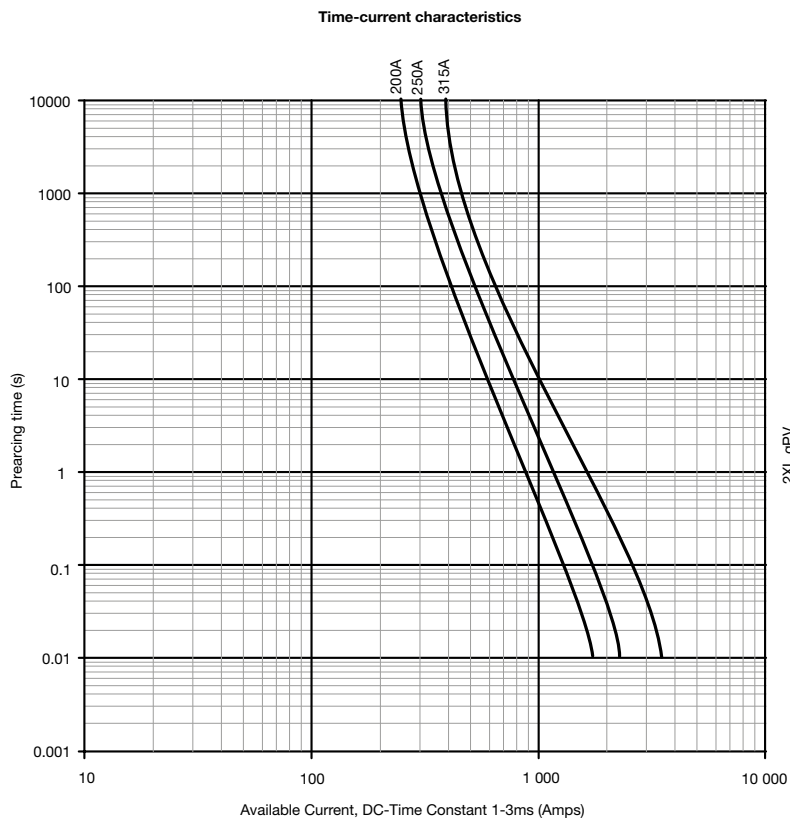

gPV knife edge fuse (3L) - Rated voltage 1000 VDC

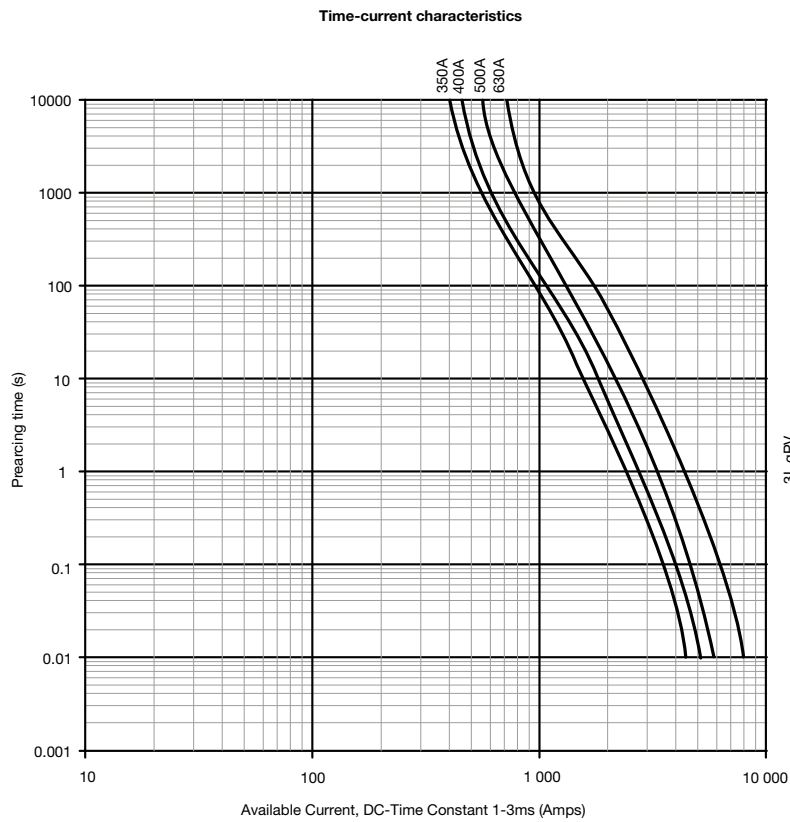

gPV knife edge fuse (3L) - Rated voltage 1500 VDC

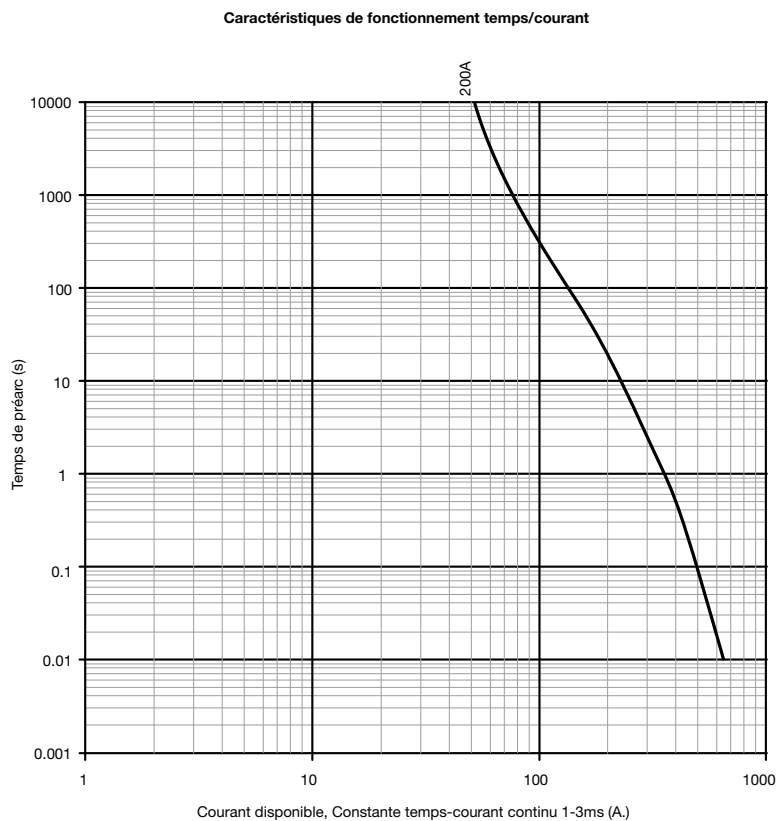

fusib-pv_029_a_1_gb_cat